

CSR006 Solid Surface Rectangular / Square Vanity Bowl Product Information

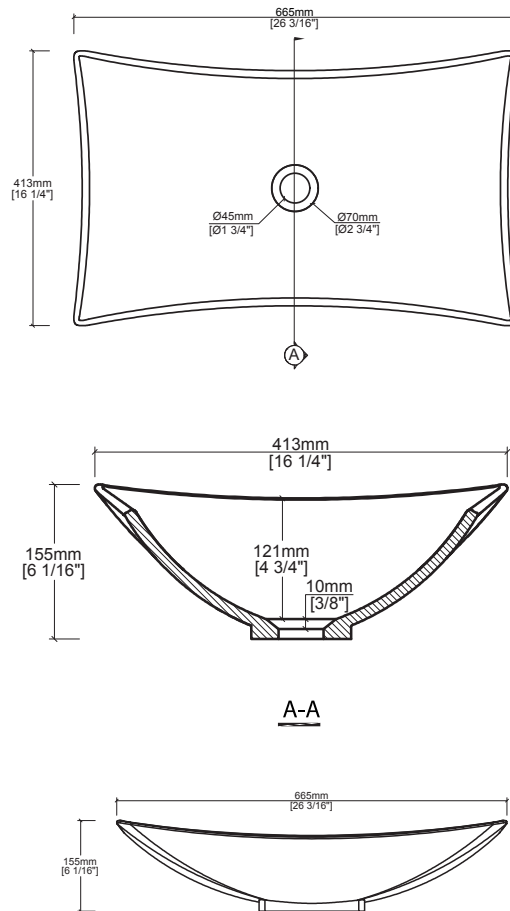

Quick Dimensions

Length	Width	Height
665 mm	413 mm	155 mm
23 3/16 in.	16 1/4 in.	6 1/16 in.

Measurements rounded to nearest 1/8" or mm.

Color Selections

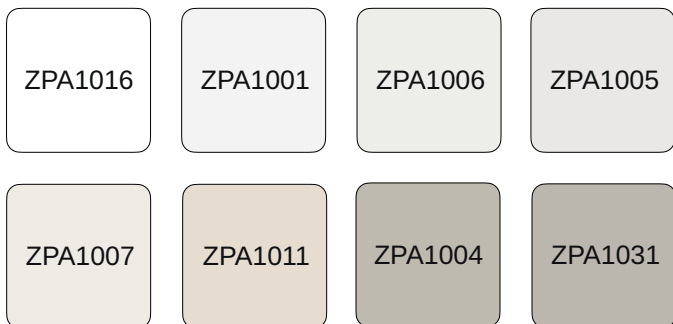

Illustration only. Contact us to request a sample. Color matching and additional colors available from our extensive color library.

Private Label / Customization / OEM

Choose colors from our comprehensive library, or have our laboratory match a precise color to your specification. We can produce custom designs and dimensions to order, and are always on-hand to find ways to make your ideas a reality.

Features & Benefits

- Precision cast from acrylic solid surface
- Easy to clean non-porous surface- resists mold, mildew and stains with proper cleaning
- Seamlessly integrates with acrylic solid surface countertop for a sleek appearance with no crevices or visible joints to catch dirt and bacteria
- Can be customized for no overflow, or custom overflow location
- Versatile and sustainable solid surface for residential and commercial applications

Certifications

- Complies with the requirements of CSA B45.5/IAPMO Z124 standard for plastic plumbing fixtures and the requirements of HUD Use of Materials Bulletin No. 73a
- Complies with the requirements of EN 14688 harmonized technical specification for sanitary appliances – wash basins
- GREENGUARD GOLD Certified for low VOC emissions